



Table of Contents

SHIMS / ANCHOR BOLTS / HAMMER DRILL BITS

pg 1 - 2



FIXED AND ADJUSTABLES

pg 3-14



FLIP-UPS AND LOW RISE

pg 15 - 18



SPIN-UPS

pg 19-21

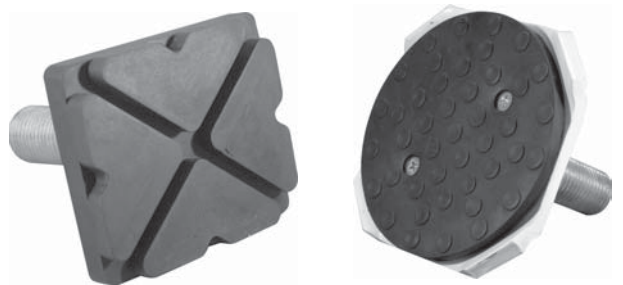

DROP-INS

pg 22-24



REPLACEMENT PADS

pg 25 - 30

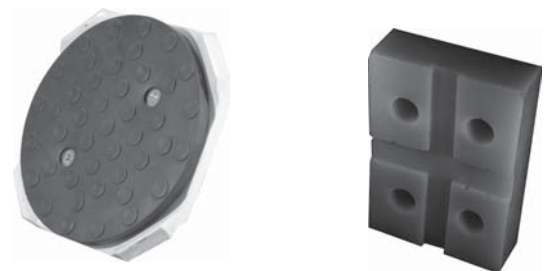



Plastic Leveling Shims

Bag Quantities



SINGLE SIZE

Part #	Thickness	Bag Qty
USH-101	1/16"	100
USH-102	1/8"	100
USH-104	1/4"	50

Variety Pack



VARIETY PACK

Qty Per Pack

Part #	Qty Per Pack		
	1/16"	1/8"	1/4"
USH-50V	25	15	10
USH-100V	50	30	20

TRU-CUT BRAND

Rebar Cutting System (Thunder Twist)

(OTHER SIZES AVAILABLE UPON REQUEST)

Overall Length Shown

SDS-Plus

SIZE	5/8" X 12"	3/4" X 12"	Adapter
Part #	RE62512	RE75012	RE-SDS

SDS-MAX

SIZE	5/8" X 12"	3/4" X 12"	Adapter
Part #	RE62512	RE75012	RE-PM

SPLINE

SIZE	5/8" X 12"	3/4" X 12"	Adapter
Part #	RE62512	RE75012	RE-PB



HILTI Anchor Bolts

5/8" Diameter Long Thread Galvanized

Part #	Size	Box Qty
WA-282530	5/8" x 4-3/4"	15
WA-3000998	5/8" x 4-3/4"	90*

3/4" Diameter Long Thread Galvanized

Part #	Size	Box Qty
WA-282535	3/4" x 4-3/4"	10
WA-3001006	3/4" x 4-3/4"	80*
WA-282536	3/4" x 5-1/2"	10
WA-3001009	3/4" x 5-1/2"	80*
WA-282537	3/4" x 7"	10
WA-3000848	3/4" x 7"	60*

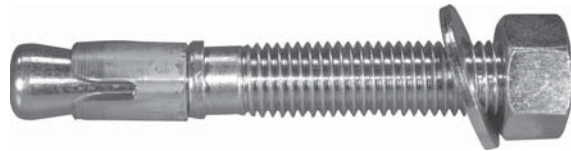

Ask about our free shipping on case Qty's !

OTHER SIZES AVAILABLE

*FREE SHIPPING

TRU-CUT BRAND Hammer Drill Bits

(OTHER SIZES AVAILABLE UPON REQUEST)

SDS-Plus

Overall Length Shown

SIZE	5/8" X 9"	5/8" X 12"	5/8" x 18"	3/4" X 9"	3/4" x 12"	3/4" x 18"
Part #	SDS62509	SDS62512	SDS62518	SDS7509	SDS75012	SDS75018

SDS-MAX (Viper Head)

SIZE	5/8" X 12"	5/8" X 18"	5/8" x 23"	3/4" X 13"	3/4" x 18"	3/4" x 23"
Part #	PMQ62512	PMQ62518	PMQ62521	PMQ75013	PMQ75018	PMQ75021

SPLINE (Viper Head)

SIZE	5/8" X 12"	5/8" X 18"	5/8" x 23"	3/4" X 12"	3/4" x 18"	3/4" x 23"
Part #	PBQ62512	PBQ62518	PBQ62523	PBQ75012	PBQ75018	PBQ75023



Fixed Height

Style B



Standard Height 6"



Custom Heights Available 4" to 12"

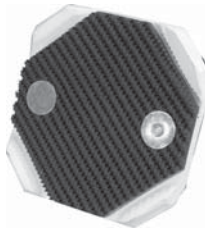

Replacement pad JOP07D

Custom Built To Fit Following Lift manufacturers

	Standard Height 6"	Custom Up to 12"
ALM (6-1/4" Round Slip On - No Bolts)	JO02B-6	JO02B-C
Benwill / Bishamon (Flat Rectangular Pad - 4 Bolt Holes)	JO03B-6	JO03B-C
Challenger / VBM / AMMCO (Old) (6" x 6" Sq - 4 Bent Corners - 2 Bolt Holes)	JO01B-6	JO01B-C
Challenger CL9/10 (4" x 4" - 2 Bolts)	JO31B-6	JO31B-C
Eagle /Grand / Ben pearson (New) / American (5" x 5" 4 Corners Turned Up - 2 Bolt Holes)	JO05B-6	JO05B-C
Force (New) (4-1/2" Round Slip On Pad - No Bolts)	JO06BP-6	JO06BP-C
Forward (Old) / Gemini / Worth (5-3/8" x 5-3/8" - 4 Bent Corners - 2 Bolt Holes)	JO04B-6	JO04B-C
Gilbarco (4 Corners Turned Up)	JO12BG-6	JO12BG-C
Globe (Flat Rectangular Pad - 4 Bolt Holes)	JO17B-6	JO17B-C
Hydra-Lift (4 Corners Turned Up)	JO11B-6	JO11B-C
Hydra-Lift (Round Pad)	JO11BP-6	JO11BP-C
Manitowoc (5" x 5" - 2 Bent Sides - Large Clip On)	JO12B-6	JO12B-C
Manitowoc (2 Sides Turned Up - Small Clip on)	JO12BP-6	JO12BP-C
Nussbaum / Phoenix / Force (Old) (5" Round pads - 2 Bolt Holes)	JO06B-6	JO06B-C
Quality Lift (4-3/4" Round Pad)	JO24B-6	JO24B-C
Western / American / Eagle / Grand / Worth (4" x 4-1/2" - Slip On "X" pad - No Bolts)	JO09B-6	JO09B-C

FEATURES

- An economical height extension made to fit many different brands.
- All Four corners are turned up for better hold.
- Painted yellow or black.



Adjustable Height

Custom Built To Fit Following Lift manufacturers	Adj. Range 6" - 9.5"	Adj Range 4" - 6"
ALM (6-1/4" Round Slip On - No Bolts)	JO02AB-69	JO02AB-46
Benwill / Bishamon (Flat Rectangular Pad - 4 Bolt Holes)	JO03AB-69	JO03AB-46
Challenger / VBM / AMMCO (Old) (6" x 6" Sq - 4 Bent Corners - 2 Bolt Holes)	JO01AB-69	JO01AB-46
Challenger CL9/10 (4" x 4" - 2 Bolts)	JO31AB-69	JO31AB-46
Eagle /Grand / Ben pearson (New) / American (5" x 5" 4 Corners Turned Up - 2 Bolt Holes)	JO05AB-69	JO05AB-46
Force (New) (4-1/2" Round Slip On Pad - No Bolts)	JO06ABP-69	JO06ABP-46
Forward (Old) / Gemini / Worth (5-3/8" x 5-3/8" - 4 Bent Corneres - 2 Bolt Holes)	JO04AB-69	JO04AB-46
Gilbarco (4 Corners Turned Up)	JO12ABG-69	JO12ABG-46
Globe (Flat Retangular Pad - 4 Bolt Holes)	JO17AB-69	JO17AB-46
Hydra-Lift (4 Corners Turned Up)	JO11AB-69	JO11AB-46
Hydra-Lift (Round Pad)	JO11ABP-69	JO11ABP-46
Manitowoc (5" x 5" - 2 Bent Sides - Large Clip On)	JO12AB-69	JO12AB-46
Manitowoc (2 Sides Turned Up - Small Clip on)	JO12ABP-69	JO12ABP-46
Nussbaum / Phoenix / Force (Old) (5" Round pads - 2 Bolt Holes)	JO06AB-69	JO06AB-46
Quality Lift (4-3/4" Round Pad)	JO24AB-69	JO24AB-46
Western / American / Eagle / Grand / Worth (4" x 4-1/2" - Slip On "X" pad - No Bolts)	JO09AB-69	JO09AB-46

Style AB



4" to 6" Adjustment

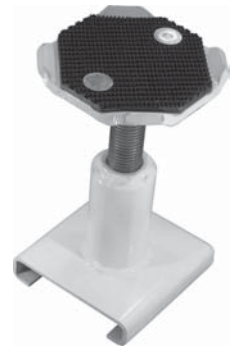

6" to 9.5" Adjustment

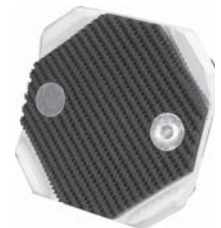

Replacement pad
JOP07D

FEATURES

- An economical height extention made to fit many different brands.
- All Four corners are turned up for better hold.
- Painted yellow or black.



Fixed Height

Style C



Standard Height 6"



Custom Heights Available 4" to 12"



Replacement pad
JOP02M

Custom Built To Fit Following Lift manufacturers

	Standard Height 6"	Custom Up to 12"
ALM (6-1/4" Round Slip On - No Bolts)	JO02C-6	JO02C-C
Benwill / Bishamon (Flat Rectangular Pad - 4 Bolt Holes)	JO03C-6	JO03C-C
Challenger / VBM / AMMCO (Old) (6" x 6" Sq - 4 Bent Corners - 2 Bolt Holes)	JO01C-6	JO01C-C
Challenger CL9/10 (4" x 4" - 2 Bolts)	JO31C-6	JO31C-C
Eagle /Grand / Ben pearson (New) / American (5" x 5" 4 Corners Turned Up - 2 Bolt Holes)	JO05C-6	JO05C-C
Force (New) (4-1/2" Round Slip On Pad - No Bolts)	JO06C-6	JO06CP-C
Forward (Old) / Gemini / Worth (5-3/8" x 5-3/8" - 4 Bent Corneres - 2 Bolt Holes)	JO04C-6	JO04C-C
Gilbarco (4 Corners Turned Up)	JO12CG-6	JO12CG-C
Globe (Flat Retangular Pad - 4 Bolt Holes)	JO17C-6	JO17C-C
Hydra-Lift (4 Corners Turned Up)	JO11C-6	JO11C-C
Hydra-Lift (Round Pad)	JO11CP-6	JO11CP-C
Manitowoc (5" x 5" - 2 Bent Sides - Large Clip On)	JO12C-6	JO12C-C
Manitowoc (2 Sides Turned Up - Small Clip on)	JO12CP-6	JO12CP-C
Nussbaum / Phoenix / Force (Old) (5" Round pads - 2 Bolt Holes)	JO06C-6	JO06C-C
Quality Lift (4-3/4" Round Pad)	JO24C-6	JO24C-C
Western / American / Eagle / Grand / Worth (4" x 4-1/2" - Slip On "X" pad - No Bolts)	JO09C-6	JO09C-C

FEATURES

- A common height extention made to fit many different brands.
- Uses Benwil pad popular in many older lifts.
- Painted yellow or black.



Adjustable Height

Custom Built To Fit Following Lift manufacturers	Adj. Range 6" - 9.5"	Adj Range 4" - 6"
ALM (6-1/4" Round Slip On - No Bolts)	JO02AC-69	JO02AC-46
Benwill / Bishamon (Flat Rectangular Pad - 4 Bolt Holes)	JO03AC-69	JO03AC-46
Challenger / VBM / AMMCO (Old) (6" x 6" Sq - 4 Bent Corners - 2 Bolt Holes)	JO01AC-69	JO01AC-46
Challenger CL9/10 (4" x 4" - 2 Bolts)	JO31AC-69	JO31AC-46
Eagle /Grand / Ben pearson (New) / American (5" x 5" 4 Corners Turned Up - 2 Bolt Holes)	JO05AC-69	JO05AC-46
Force (New) (4-1/2" Round Slip On Pad - No Bolts)	JO06ACP-69	JO06ACP-46
Forward (Old) / Gemini / Worth (5-3/8" x 5-3/8" - 4 Bent Corneres - 2 Bolt Holes)	JO04AC-69	JO04AC-46
Gilbarco (4 Corners Turned Up)	JO12ACG-69	JO12ACG-46
Globe (Flat Retangular Pad - 4 Bolt Holes)	JO17AC-69	JO17AC-46
Hydra-Lift (4 Corners Turned Up)	JO11AC-69	JO11AC-46
Hydra-Lift (Round Pad)	JO11ACP-69	JO11ACP-46
Manitowoc (5" x 5" - 2 Bent Sides - Large Clip On)	JO12AC-69	JO12AC-46
Manitowoc (2 Sides Turned Up - Small Clip on)	JO12ACP-69	JO12ACP-46
Nussbaum / Phoenix / Force (Old) (5" Round pads - 2 Bolt Holes)	JO06AC-69	JO06AC-46
Quality Lift (4-3/4" Round Pad)	JO24AC-69	JO24AC-46
Western / American / Eagle / Grand / Worth (4" x 4-1/2" - Slip On "X" pad - No Bolts)	JO09AC-69	JO09AC-46

Style AC



4" to 6" Adjustment



6" to 9.5" Adjustment



Replacement pad
JOP02M

FEATURES

- A common height extention made to fit many different brands.
- Uses Benwil pad popular in many older lifts.
- Painted yellow or black.



Fixed Height

Style E



Standard Height 6"



Custom Heights Available 4" to 12"

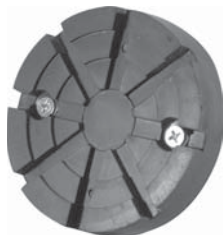

Replacement pad JOP03M

Custom Built To Fit Following Lift manufacturers

	Standard Height 6"	Custom Up to 12"
ALM (6-1/4" Round Slip On - No Bolts)	JO02E-6	JO02E-C
Benwill / Bishamon (Flat Rectangular Pad - 4 Bolt Holes)	JO03E-6	JO03E-C
Challenger / VBM / AMMCO (Old) (6" x 6" Sq - 4 Bent Corners - 2 Bolt Holes)	JO01E-6	JO01E-C
Challenger CL9/10 (4" x 4" - 2 Bolts)	JO31E-6	JO31E-C
Eagle /Grand / Ben pearson (New) / American (5" x 5" 4 Corners Turned Up - 2 Bolt Holes)	JO05E-6	JO05E-C
Force (New) (4-1/2" Round Slip On Pad - No Bolts)	JO06EP-6	JO06EP-C
Forward (Old) / Gemini / Worth (5-3/8" x 5-3/8" - 4 Bent Corneres - 2 Bolt Holes)	JO04E-6	JO04E-C
Gilbarco (4 Corners Turned Up)	JO12EG-6	JO12EG-C
Globe (Flat Retangular Pad - 4 Bolt Holes)	JO17E-6	JO17E-C
Hydra-Lift (4 Corners Turned Up)	JO11E-6	JO11E-C
Hydra-Lift (Round Pad)	JO11EP-6	JO11EP-C
Manitowoc (5" x 5" - 2 Bent Sides - Large Clip On)	JO12E-6	JO12E-C
Manitowoc (2 Sides Turned Up - Small Clip on)	JO12EP-6	JO12EP-C
Nussbaum / Phoenix / Force (Old) (5" Round pads - 2 Bolt Holes)	JO06E-6	JO06E-C
Quality Lift (4-3/4" Round Pad)	JO24E-6	JO24E-C
Western / American / Eagle / Grand / Worth (4" x 4-1/2" - Slip On "X" pad - No Bolts)	JO09E-6	JO09E-C

FEATURES

- A great height extension made to fit many different brands.
- Uses the well designed Nussbaum style pad.
- Painted yellow or black.



Adjustable Height

Custom Built To Fit Following Lift manufacturers	Adj. Range 6" - 9.5"	Adj Range 4" - 6"
ALM (6-1/4" Round Slip On - No Bolts)	JO02AE-69	JO02AE-46
Benwill / Bishamon (Flat Rectangular Pad - 4 Bolt Holes)	JO03AE-69	JO03AE-46
Challenger / VBM / AMMCO (Old) (6" x 6" Sq - 4 Bent Corners - 2 Bolt Holes)	JO01AE-69	JO01AE-46
Challenger CL9/10 (4" x 4" - 2 Bolts)	JO31AE-69	JO31AE-46
Eagle /Grand / Ben pearson (New) / American (5" x 5" 4 Corners Turned Up - 2 Bolt Holes)	JO05AE-69	JO05AE-46
Force (New) (4-1/2" Round Slip On Pad - No Bolts)	JO06AEP-69	JO06AEP-46
Forward (Old) / Gemini / Worth (5-3/8" x 5-3/8" - 4 Bent Corneres - 2 Bolt Holes)	JO04AE-69	JO04AE-46
Gilbarco (4 Corners Turned Up)	JO12AEG-69	JO12AEG-46
Globe (Flat Retangular Pad - 4 Bolt Holes)	JO17AE-69	JO17AE-46
Hydra-Lift (4 Corners Turned Up)	JO11AE-69	JO11AE-46
Hydra-Lift (Round Pad)	JO11AEP-69	JO11AEP-46
Manitowoc (5" x 5" - 2 Bent Sides - Large Clip On)	JO12AE-69	JO12AE-46
Manitowoc (2 Sides Turned Up - Small Clip on)	JO12AEP-69	JO12AEP-46
Nussbaum / Phoenix / Force (Old) (5" Round pads - 2 Bolt Holes)	JO06AE-69	JO06AE-46
Quality Lift (4-3/4" Round Pad)	JO24AE-69	JO24AE-46
Western / American / Eagle / Grand / Worth (4" x 4-1/2" - Slip On "X" pad - No Bolts)	JO09AE-69	JO09AE-46

Style AE



4" to 6" Adjustment



6" to 9.5" Adjustment

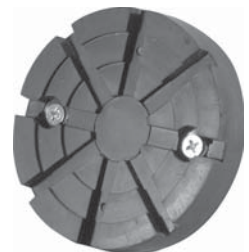

Replacement pad
JOP03M

FEATURES

- A great height extension made to fit many different brands.
- Uses the well designed Nussbaum style pad.
- Painted yellow or black.



Fixed Height

Style F



Standard Height 6"



Custom Heights Available 4" to 12"



Replacement pad JOP06M

Custom Built To Fit Following Lift manufacturers

	Standard Height 6"	Custom Up to 12"
ALM (6-1/4" Round Slip On - No Bolts)	JO02F-6	JO02F-C
Benwill / Bishamon (Flat Rectangular Pad - 4 Bolt Holes)	JO03F-6	JO03F-C
Challenger / VBM / AMMCO (Old) (6" x 6" Sq - 4 Bent Corners - 2 Bolt Holes)	JO01F-6	JO01F-C
Challenger CL9/10 (4" x 4" - 2 Bolts)	JO31F-6	JO31F-C
Eagle /Grand / Ben pearson (New) / American (5" x 5" 4 Corners Turned Up - 2 Bolt Holes)	JO05F-6	JO05F-C
Force (New) (4-1/2" Round Slip On Pad - No Bolts)	JO06FP-6	JO06FP-C
Forward (Old) / Gemini / Worth (5-3/8" x 5-3/8" - 4 Bent Corneres - 2 Bolt Holes)	JO04F-6	JO04F-C
Gilbarco (4 Corners Turned Up)	JO12FG-6	JO12FG-C
Globe (Flat Retangular Pad - 4 Bolt Holes)	JO17F-6	JO17F-C
Hydra-Lift (4 Corners Turned Up)	JO11F-6	JO11F-C
Hydra-Lift (Round Pad)	JO11FP-6	JO11FP-C
Manitowoc (5" x 5" - 2 Bent Sides - Large Clip On)	JO12F-6	JO12F-C
Manitowoc (2 Sides Turned Up - Small Clip on)	JO12FP-6	JO12FP-C
Nussbaum / Phoenix / Force (Old) (5" Round pads - 2 Bolt Holes)	JO06F-6	JO06F-C
Quality Lift (4-3/4" Round Pad)	JO24F-6	JO24F-C
Western / American / Eagle / Grand / Worth (4" x 4-1/2" - Slip On "X" pad - No Bolts)	JO09F-6	JO09F-C

FEATURES

- This height extension has no bolts on surface that may scratch undercarriage.
- Large bearing surface makes this extension very user friendly.
- Painted yellow or black.



Adjustable Height

Custom Built To Fit Following Lift manufacturers	Adj. Range 6" - 9.5"	Adj Range 4" - 6"
ALM (6-1/4" Round Slip On - No Bolts)	JO02AF-69	JO02AF-46
Benwill / Bishamon (Flat Rectangular Pad - 4 Bolt Holes)	JO03AF-69	JO03AF-46
Challenger / VBM / AMMCO (Old) (6" x 6" Sq - 4 Bent Corners - 2 Bolt Holes)	JO01AF-69	JO01AF-46
Challenger CL9/10 (4" x 4" - 2 Bolts)	JO31AF-69	JO31AF-46
Eagle /Grand / Ben pearson (New) / American (5" x 5" 4 Corners Turned Up - 2 Bolt Holes)	JO05AF-69	JO05AF-46
Force (New) (4-1/2" Round Slip On Pad - No Bolts)	JO06AFP-69	JO06AFP-46
Forward (Old) / Gemini / Worth (5-3/8" x 5-3/8" - 4 Bent Corneres - 2 Bolt Holes)	JO04AF-69	JO04AF-46
Gilbarco (4 Corners Turned Up)	JO12AFG-69	JO12AFG-46
Globe (Flat Retangular Pad - 4 Bolt Holes)	JO17AF-69	JO17AF-46
Hydra-Lift (4 Corners Turned Up)	JO11AF-69	JO11AF-46
Hydra-Lift (Round Pad)	JO11AFP-69	JO11AFP-46
Manitowoc (5" x 5" - 2 Bent Sides - Large Clip On)	JO12AF-69	JO12AF-46
Manitowoc (2 Sides Turned Up - Small Clip on)	JO12AFP-69	JO12AFP-46
Nussbaum / Phoenix / Force (Old) (5" Round pads - 2 Bolt Holes)	JO06AF-69	JO06AF-46
Quality Lift (4-3/4" Round Pad)	JO24AF-69	JO24AF-46
Western / American / Eagle / Grand / Worth (4" x 4-1/2" - Slip On "X" pad - No Bolts)	JO09AF-69	JO09AF-46

Style AF



4" to 6" Adjustment



6" to 9.5" Adjustment



Replacement pad
JOP06M

FEATURES

- This height extention has no bolts on surface that may scratch undercarriage.
- Large bearing surface makes this extention very user friendly.
- Painted yellow or black.

www.allpartsupply.com
1-800-381-1330 - Fax 817-284-2935



Fixed Height

Style K



Standard Height 6"



Custom Heights Available 4" to 12"

Custom Built To Fit Following Lift manufacturers

	Standard Height 6"	Custom Up to 12"
ALM (6-1/4" Round Slip On - No Bolts)	JO02K-6	JO02K-C
Benwill / Bishamon (Flat Rectangular Pad - 4 Bolt Holes)	JO03K-6	JO03K-C
Challenger / VBM / AMMCO (Old) (6" x 6" Sq - 4 Bent Corners - 2 Bolt Holes)	JO01K-6	JO01K-C
Challenger CL9/10 (4" x 4" - 2 Bolts)	JO31K-6	JO31K-C
Eagle /Grand / Ben pearson (New) / American (5" x 5" 4 Corners Turned Up - 2 Bolt Holes)	JO05K-6	JO05K-C
Force (New) (4-1/2" Round Slip On Pad - No Bolts)	JO06KP-6	JO06KP-C
Forward (Old) / Gemini / Worth (5-3/8" x 5-3/8" - 4 Bent Corneres - 2 Bolt Holes)	JO04K-6	JO04K-C
Gilbarco (4 Corners Turned Up)	JO12KG-6	JO12KG-C
Globe (Flat Retangular Pad - 4 Bolt Holes)	JO17K-6	JO17K-C
Hydra-Lift (4 Corners Turned Up)	JO11K-6	JO11K-C
Hydra-Lift (Round Pad)	JO11KP-6	JO11KP-C
Manitowoc (5" x 5" - 2 Bent Sides - Large Clip On)	JO12K-6	JO12K-C
Manitowoc (2 Sides Turned Up - Small Clip on)	JO12KP-6	JO12KP-C
Nussbaum / Phoenix / Force (Old) (5" Round pads - 2 Bolt Holes)	JO06K-6	JO06K-C
Quality Lift (4-3/4" Round Pad)	JO24K-6	JO24K-C
Western / American / Eagle / Grand / Worth (4" x 4-1/2" - Slip On "X" pad - No Bolts)	JO09K-6	JO09K-C

FEATURES

- The most economical height extention made to fit many different brands
- Two sides are turned up for better hold.
- Painted yellow or black.



Adjustable Height

Custom Built To Fit Following Lift manufacturers	Adj. Range 6" - 9.5"	Adj Range 4" - 6"
ALM (6-1/4" Round Slip On - No Bolts)	JO02AK-69	JO02AK-46
Benwill / Bishamon (Flat Rectangular Pad - 4 Bolt Holes)	JO03AK-69	JO03AK-46
Challenger / VBM / AMMCO (Old) (6" x 6" Sq - 4 Bent Corners - 2 Bolt Holes)	JO01AK-69	JO01AK-46
Challenger CL9/10 (4" x 4" - 2 Bolts)	JO31AK-69	JO31AK-46
Eagle /Grand / Ben pearson (New) / American (5" x 5" 4 Corners Turned Up - 2 Bolt Holes)	JO05AK-69	JO05AK-46
Force (New) (4-1/2" Round Slip On Pad - No Bolts)	JO06AKP-69	JO06AKP-46
Forward (Old) / Gemini / Worth (5-3/8" x 5-3/8" - 4 Bent Corneres - 2 Bolt Holes)	JO04AK-69	JO04AK-46
Gilbarco (4 Corners Turned Up)	JO12AKG-69	JO12AKG-46
Globe (Flat Retangular Pad - 4 Bolt Holes)	JO17AK-69	JO17AK-46
Hydra-Lift (4 Corners Turned Up)	JO11AK-69	JO11AK-46
Hydra-Lift (Round Pad)	JO11AKP-69	JO11AKP-46
Manitowoc (5" x 5" - 2 Bent Sides - Large Clip On)	JO12AK-69	JO12AK-46
Manitowoc (2 Sides Turned Up - Small Clip on)	JO12AKP-69	JO12AKP-46
Nussbaum / Phoenix / Force (Old) (5" Round pads - 2 Bolt Holes)	JO06AK-69	JO06AK-46
Quality Lift (4-3/4" Round Pad)	JO24AK-69	JO24AK-46
Western / American / Eagle / Grand / Worth (4" x 4-1/2" - Slip On "X" pad - No Bolts)	JO09AK-69	JO09AK-46

Style AK



4" to 6" Adjustment



6" to 9.5" Adjustment

FEATURES

- The most economical height extention made to fit many different brands
- Two sides are turned up for better hold.
- Painted yellow or black.



Fixed Height

Style R

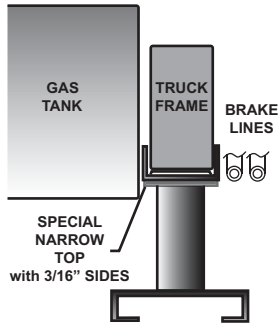

Standard Height 6"



Custom Heights Available 4" to 12"

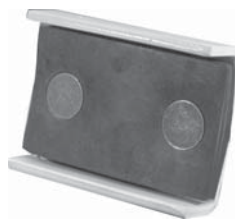

Replacement pad JOP20D

Custom Built To Fit Following Lift manufacturers

	Standard Height 6"	Custom Up to 12"
ALM (6-1/4" Round Slip On - No Bolts)	JO02R-6	JO02R-C
Benwill / Bishamon (Flat Rectangular Pad - 4 Bolt Holes)	JO03R-6	JO03R-C
Challenger / VBM / AMMCO (Old) (6" x 6" Sq - 4 Bent Corners - 2 Bolt Holes)	JO01R-6	JO01R-C
Challenger CL9/10 (4" x 4" - 2 Bolts)	JO31R-6	JO31R-C
Eagle /Grand / Ben pearson (New) / American (5" x 5" 4 Corners Turned Up - 2 Bolt Holes)	JO05R-6	JO05R-C
Force (New) (4-1/2" Round Slip On Pad - No Bolts)	JO06RP-6	JO06RP-C
Forward (Old) / Gemini / Worth (5-3/8" x 5-3/8" - 4 Bent Corneres - 2 Bolt Holes)	JO04R-6	JO04R-C
Gilbarco (4 Corners Turned Up)	JO12RG-6	JO12RG-C
Globe (Flat Retangular Pad - 4 Bolt Holes)	JO17R-6	JO17R-C
Hydra-Lift (4 Corners Turned Up)	JO11R-6	JO11R-C
Hydra-Lift (Round Pad)	JO11RP-6	JO11RP-C
Manitowoc (5" x 5" - 2 Bent Sides - Large Clip On)	JO12R-6	JO12R-C
Manitowoc (2 Sides Turned Up - Small Clip on)	JO12RP-6	JO12RP-C
Nussbaum / Phoenix / Force (Old) (5" Round pads - 2 Bolt Holes)	JO06R-6	JO06R-C
Quality Lift (4-3/4" Round Pad)	JO24R-6	JO24R-C
Western / American / Eagle / Grand / Worth (4" x 4-1/2" - Slip On "X" pad - No Bolts)	JO09R-6	JO09R-C

FEATURES

- A great height extension made to fit between brake lines and gas tanks of Ram Trucks.
- Made to fit any lift brand.
- Painted yellow or black.



Adjustable Height

Custom Built To Fit Following Lift manufacturers	Adj. Range 6" - 9.5"	Adj Range 4" - 6"
ALM (6-1/4" Round Slip On - No Bolts)	JO02AR-69	JO02AR-46
Benwill / Bishamon (Flat Rectangular Pad - 4 Bolt Holes)	JO03AR-69	JO03AR-46
Challenger / VBM / AMMCO (Old) (6" x 6" Sq - 4 Bent Corners - 2 Bolt Holes)	JO01AR-69	JO01AR-46
Challenger CL9/10 (4" x 4" - 2 Bolts)	JO31AR-69	JO31AR-46
Eagle /Grand / Ben pearson (New) / American (5" x 5" 4 Corners Turned Up - 2 Bolt Holes)	JO05AR-69	JO05AR-46
Force (New) (4-1/2" Round Slip On Pad - No Bolts)	JO06ARP-69	JO06ARP-46
Forward (Old) / Gemini / Worth (5-3/8" x 5-3/8" - 4 Bent Corneres - 2 Bolt Holes)	JO04AR-69	JO04AR-46
Gilbarco (4 Corners Turned Up)	JO12ARG-69	JO12ARG-46
Globe (Flat Retangular Pad - 4 Bolt Holes)	JO17AR-69	JO17AR-46
Hydra-Lift (4 Corners Turned Up)	JO11AR-69	JO11AR-46
Hydra-Lift (Round Pad)	JO11ARP-69	JO11ARP-46
Manitowoc (5" x 5" - 2 Bent Sides - Large Clip On)	JO12AR-69	JO12AR-46
Manitowoc (2 Sides Turned Up - Small Clip on)	JO12ARP-69	JO12ARP-46
Nussbaum / Phoenix / Force (Old) (5" Round pads - 2 Bolt Holes)	JO06AR-69	JO06AR-46
Quality Lift (4-3/4" Round Pad)	JO24AR-69	JO24AR-46
Western / American / Eagle / Grand / Worth (4" x 4-1/2" - Slip On "X" pad - No Bolts)	JO09AR-69	JO09AR-46

Style AR

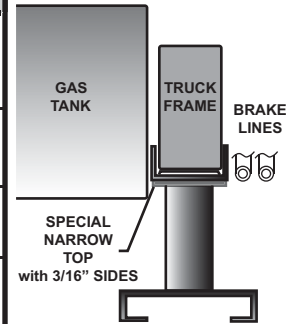

4" to 6" Adjustment



6" to 9.5" Adjustment



Replacement pad
JOP20D

FEATURES

- A great height extention made to fit between brake lines and gas tanks of Ram Trucks.
- Made to fit any lift brand.
- Painted yellow or black.



For Flip Ups

Style 7B



Uses Pad JOP21D

Part #	Description	Heights
JO07B	Rotary / General	9" or 11"

A 3" x 5" top commonly used on

Rotary / General

Hangers for these height extensions are available.
Available w/top for Ram Trucks

Style 7C



Uses Pad JOP05M

Uses a high quality molded pad.

Part #	Description	Heights
JO15C-4	Challenger / Weaver	4"
JO07C-4	Rotary / General	4"
JO08C-4	Western	4"

Challenger / General / Rotary / Western / Weaver

Style 7D



Uses Pad JOP05M

Uses a high quality molded pad.

Part #	Description	Heights
JO15D	Challenger / Weaver	Flat
JO07D	Rotary / General	Flat
JO08D	Western	Flat

Challenger / General / Rotary / Western / Weaver



For Flip Ups

Style 7AB

Part #	Description	Heights
JO07AB	Rotary / General	7" - 10"
JO08AB	Western	7" - 10"

Uses a 5.5" x 5/5" top

Rotary / General



Uses Pad JOP07D

Style 7AC

Part #	Description	Heights
JO15AC-46	Challenger / Weaver	4" - 6"
JO07AC-46	Rotary / General	4" - 6"
JO08AC-46	Western	4" - 6"

**Challenger / General / Rotary
/ Western / Weaver**



Uses Pad JOP05M
Uses a high quality molded pad.

Style 13B

Part #	Description	Heights
JO14B	Globe	9" or 11"
JO13B	Manitowoc / Gilbarco	9" or 11"
JO08B	Western	9" or 11"

A 3" x 6" top commonly used on

Gilbarco / Globe / Manitowoc / Western

Available w/top for Ram Trucks



Uses Pad JOP23D



For Flip Ups

Style 14C



Uses Pad JOP07D

Uses a 5.5" x 5.5" top

Part #	Description	Heights
JO14C	Globe	8.5"
JO13C	Manitowoc / Gilbarco	8.5"

Gilbarco / Globe / Manitowoc / Western

Style 14AC



Uses Pad JOP07D

Uses a 5.5" x 5.5" top

Part #	Description	Heights
JO14AC-710	Globe	7" - 10"
JO13AC-710	Manitowoc / Gilbarco	7" - 10"

Gilbarco / Globe / Manitowoc / Western

Style 15B



Uses Pad JOP23D

Part #	Description	Heights
JO15B	Challenger / Weaver	9" or 11"
JO28B	Wheeltronics	9"

A 3" x 6" top commonly used on

Challenger / Weaver

AVAILABLE w/RAM TOP



Low Rise Lifts

Style 19A

Part #	Description	Heights
JO19A-4	Fixed Height	4"
JO19AA-46	Adjustable Height	4" - 6"
JO19AA-58	Adjustable Height	5" - 8"



Any Low Rise Pad Lift

Uses Pad JOP01M
Uses a 5.5" x 5.5" top

Style 19B

Part #	Description	Heights
JO19B-4	Fixed Height	4"
JO19AB-46	Adjustable Height	4" - 6"
JO19AB-58	Adjustable Height	5" - 8"



Any Low Rise Pad Lift

Uses Pad JOP06M
Uses high quality 6" round molded pad

Rubber Blocks

Part #	Description	Heights
JORB-1	Solid Rubber Block	1.5"
JORB-3	Solid Rubber Block	3"

Solid 4-3/4" x 6" Molded Rubber Blocks





Spin Ups

Style SP4

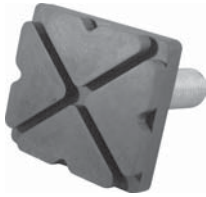

Uses Pad JOP04M

A 4" X 4-1/2" top commonly used on

Threads	Thread Length		
	4"	6"	8"
1" - 8	SP4-116-4	SP4-116-6	SP4-116-8
1-1/4" - 7	SP4-120-4	SP4-120-6	SP4-120-8
1-3/8" - 6	SP4-122-4	SP4-122-6	SP4-122-8

Western / American / Eagle (old) / Grand / Worth (old)

1-3/8"-6 Threads Most Common

Style SP5

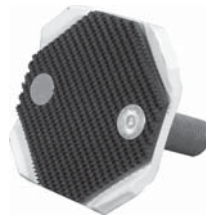

Uses Pad JOP07D

A 5" x 5" top commonly used on

Threads	Thread Length		
	4"	6"	8"
1" - 8	SP5-116-4	SP5-116-6	SP5-116-8
1-1/4" - 7	SP5-120-4	SP5-120-6	SP5-120-8
1-3/8" - 6	SP5-122-4	SP5-122-6	SP5-122-8

Eagle / Grand / Ben Pearson (New)

1-3/8" - 6 Threads Most Common

Style SP5.5

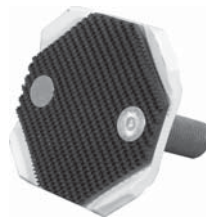

Uses Pad JOP07D

A 5-3/8" x 5-3/8" top commonly used on

Threads	Thread Length		
	4"	6"	8"
1" - 8	SP5.5-116-4	SP5.5-116-6	SP5.5-116-8
1-1/4" - 7	SP5.5-120-4	SP5.5-120-6	SP5.5-120-8
1-3/8" - 6	SP5.5-122-4	SP5.5-122-6	SP5.5-122-8

Forward / Gemini / Worth

1-3/8" - 6 Threads Most Common



Spin Ups

Threads	Thread Length		
	4"	6"	8"
1.0 - 8	SP6-116-4	SP6-116-6	SP6-116-8
1.25 - 7	SP6-120-4	SP6-120-6	SP6-120-8
1.375 - 6	SP6-122-4	SP6-122-6	SP6-122-8

Style SP6



Uses Pad JOP01M
A 6" X 6" top commonly used on

Challenger / VBM / AMMCO (Old)

1-3/8"-6 Threads Most Common

Threads	Thread Length		
	4"	6"	8"
36-4.0	SPCL-136-4	SPCL-136-6	SPCL-136-8
1-1/4" - 7	SPCL-120-4	SPCL-120-6	SPCL-120-8
1-3/8" - 6	SPCL-122-4	SPCL-122-6	SPCL-122-8

Style SPCL



Uses Pad JOP09M
Most Common 1-3/8"-6 or
36-4.0 Threads

Challenger CL 9/10

Threads	Thread Length		
	4"	6"	8"
1.0 - 8	SPE-116-4	SPE-116-6	SPE-116-8
1.25 - 7	SPE-120-4	SPE-120-6	SPE-120-8
1.375 - 6	SPE122-4	SPE-122-6	SPE-122-8

Style SPE

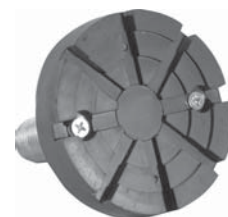

Uses Pad JOP03M
A 5" round top commonly used on

Nussbaum / Phoenix / Force (Old)



Spin Ups

Style SPF



Uses Pad JOP06M

A 6" round top commonly used on

Threads	Thread Length		
	4"	6"	8"
1.0 - 8	SPF-116-4	SPF-116-6	SPF-116-8
1.25 - 7	SPF-120-4	SPF-120-6	SPF-120-8
1.375 - 6	SPF122-4	SPF-122-6	SPF-122-8

ALM

Style SPQ



Uses Pad JOP25M

Threads	Thread Length		
	4"	6"	8"
1" - 8	SPQ-116-4	SPQ-116-6	SPQ-116-8
1-1/4" - 7	SPQ-120-4	SPQ-120-6	SPQ-120-8
1-3/8" - 6	SPQ-122-4	SPQ-122-6	SPQ-122-8

Style SPR



Uses Pad JOP20D

Threads	Thread Length		
	4"	6"	8"
1" - 8	SPR-116-4	SPR-116-6	SPR-116-8
1-1/4" - 7	SPR-120-4	SPR-120-6	SPR-120-8
1-3/8" - 6	SPR-122-4	SPR-122-6	SPR-122-8

Custom top designed to prevent damage to brake lines on Ram Trucks



Drop Ins

Pin Diameter	Extension Height		Pad
	3"	6"	
1-1/8"	DI-118-3	DI-118-6	DI5.5-118
1-1/4"	DI-120-3	DI-120-6	DI5.5-120
1-3/8"	DI-122-3	DI-122-6	DI5.5-122
1-1/2"	DI-124-3	DI-124-6	DI5.5-124

Forward / Gemini / Worth
1-1/4" Pin Most Common

Style DI5.5

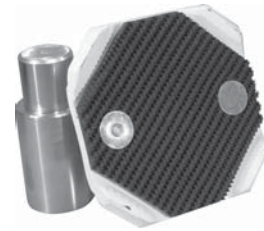

Uses Pad JOP07D

A 5-3/8" X 5-3/8" top commonly used on

Pin Diameter	Extension Height		Pad
	3"	6"	
1-1/8"	DI-118-3	DI-118-6	DIB-118
1-1/4"	DI-120-3	DI-120-6	DIB-120
1-3/8"	DI-122-3	DI-122-6	DIB-122
1-1/2"	DI-124-3	DI-124-6	DIB-124

Bend Pak
1-3/8" Pin Most Common

Style DIB



Uses Pad JOP12M

A 4.75" X 4.75" top commonly used on

Pin Diameter	Extension Height		Pad
	3"	6"	
1-1/8"	DI-118-3	DI-118-6	DIF-118
1-1/4"	DI-120-3	DI-120-6	DIF-120
1-3/8"	DI-122-3	DI-122-6	DIF-122
1-1/2"	DI-124-3	DI-124-6	DIF-124

ALM
1-1/2" Pin Most Common

Style DIF



Uses Pad JOP06M

A 6" round top commonly used on



Drop Ins

Style DIG



Uses Pad JOP05M
A 4" x 5" top commonly used on

Pin Diameter	Extension Height		Pad
	3"	6"	
1-1/8"	DI-118-3	DI-118-6	DIG-118
1-1/4"	DI-120-3	DI-120-6	DIG-120
1-3/8"	DI-122-3	DI-122-6	DIG-122
1-1/2"	DI-124-3	DI-124-6	DIG-124

AMMCO / Ben Pearson

1-1/2" Pin Most Common

Style DIR



Uses Pad JOP20D

Pin Diameter	Extension Height		Pad
	3"	6"	
1-1/8"	DI-118-3	DI-118-6	DI5.5-118
1-1/4"	DI-120-3	DI-120-6	DI5.5-120
1-3/8"	DI-122-3	DI-122-6	DI5.5-122
1-1/2"	DI-124-3	DI-124-6	DI5.5-124

Custom top designed to prevent damage to brake lines on Ram Trucks

Style DIS

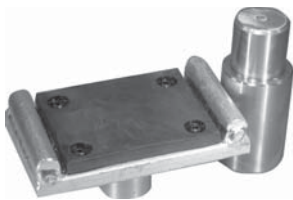

Uses Pad JOP22D
A 6" round top commonly used on

Pin Diameter	Extension Height		Pad
	3"	6"	
1-1/8"	DI-118-3	DI-118-6	DIS-118
1-1/4"	DI-120-3	DI-120-6	DIS-120
1-3/8"	DI-122-3	DI-122-6	DIS-122
1-1/2"	DI-124-3	DI-124-6	DIS-124

Rotary SPO 12



Drop Ins

Pin Diameter	Extension Height		Pad
	3"	6"	
1-1/8"	DI-118-3	DI-118-6	DIW-118
1-1/4"	DI-120-3	DI-120-6	DIW-120
1-3/8"	DI-122-3	DI-122-6	DIW-122
1-1/2"	DI-124-3	DI-124-6	DIW-124

Wheeltronics

1-1/4" Long Pin Most Common

Style DIW



Uses Pad JOP17M

A molded round top commonly used on

Pin Diameter	Extension Height		Pad
	3"	6"	
1-1/8"	DI-118-3	DI-118-6	DIWR-118
1-1/4"	DI-120-3	DI-120-6	DIWR-120
1-3/8"	DI-122-3	DI-122-6	DIWR-122
1-1/2"	DI-124-3	DI-124-6	DIWR-124

Wheeltronics

1-1/4" Long Pin Most Common

Style DIW Round



Uses Pad JOP16M

A molded round top commonly used on

Don't see the Height Extension you need?

call us

we can make it!



Replacement Pads

Alamo Lifts

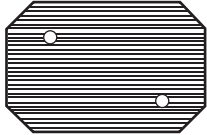

Description	4 Piece Kit	Individual Pad
Heavy Die Cut Material	JOK24D	JOP24D

ALM Lifts



Description	4 Piece Kit	Individual Pad
Molded Rubber Pad (like OEM)	JOK06M	JOP06M
Long Lasting Urethane (Yellow)	JOK06U	JOP06U

AMMCO / Ben Pearson / Challenger / Weaver



Description	4 Piece Kit	Individual Pad
Molded Rubber Pad (like OEM)	JOK05M	JOP05M
Long Lasting Urethane (Yellow)	JOK05U	JOP05U

Bend Pak Square



Slip On Shown

Description	4 Piece Kit	Individual Pad
Molded Rubber Pad (Bolt On)	JOK12M	JOP12M
Molded Rubber Pad (Slip On)	JOK12O	JOP12O



Replacement Pads

Benwil / Bishamon

Description	4 Piece Kit	Individual Pad
Heavy Die Cut Material	JOK02D	JOP02D
Molded Rubber Pad	JOK02M	JOP02M
Long Lasting Urethane (Yellow)	JOK02U	JOP02U



Challenger CL9/10

Description	4 Piece Kit	Individual Pad
Heavy Die Cut Material	JOK09D	JOP09D
Molded Rubber Pad	JOK09M	JOP09M
Rubber Pad (Like OEM)	JOK09O	JOP09O



Challenger / VBM Round

(replaces Original 8 Sided Pad)

Description	4 Piece Kit	Individual Pad
Heavy Die Cut Material	JOK01D	JOP01D
Molded Rubber Pad	JOK01M	JOP01M
Long Lasting Urethane (Yellow)	JOK01U	JOP01U





Replacement Pads

Forward / Eagle / Gemini / Worth / American

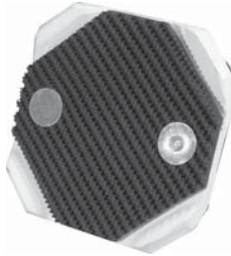

Description	4 Piece Kit	Individual Pad
Heavy Die Cut Material (8 sided)	JOK07D	JOP07D
Molded Rubber Pad	JOK07M	JOP07M
Long Lasting Urethane (Yellow)	JOK07U	JOP07U

Gilbarco / Manitowoc



Description	4 Piece Kit	Individual Pad
Molded Rubber Pad (Large) 4"	JOK10M	JOP10M
Molded Rubber Pad (Small) 2-7/8"	JOK11M	JOP11M

Globe Rectangle



Description	4 Piece Kit	Individual Pad
Heavy Die Cut Material	JOK08D	JOP08D
Molded Rubber Pad	JOK08M	JOP08M
Long Lasting Urethane (Yellow)	JOK08U	JOP08U



Replacement Pads

Globe / Ford Smith Round

Description	4 Piece Kit	Individual Pad
Heavy Die Cut Material	JOK26D	JOP26D

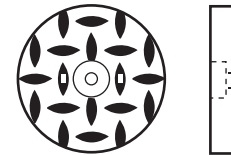

Nussbaum / Pheonix / Force (Old)

Description	4 Piece Kit	Individual Pad
Heavy Die Cut Material	JOK03D	JOP03D
Molded Rubber Pad (like OEM)	JOK03M	JOP03M
Long Lasting Urethane (Yellow)	JOK03U	JOP03U

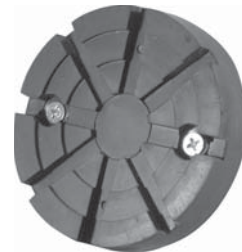

Force (New Style)

Description	4 Piece Kit	Individual Pad
Molded Rubber Pad (like OEM)	JOK18M	JOP18M



For Flip Up Height Extentions

Description	4 Piece Kit	Individual Pad
Heavy Die Cut Material 3" x 5"	JOK21D	JOP21D
Heavy Die Cut Material 3" x 6"	JOK23D	JOP23D





Replacement Pads

For Ram Pick Ups



Description	4 Piece Kit	Individual Pad
Heavy Die Cut Material	JOK20D	JOP20D

Quality



Description	4 Piece Kit	Individual Pad
Molded Rubber Pad	JOK25M	JOP25M

PMW / Lin-o-tronics

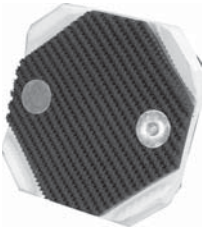

Description	4 Piece Kit	Individual Pad
Heavy Die Cut Material	JOK27D	JOP27D

Rotary SPO 12

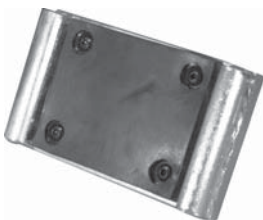

Description	4 Piece Kit	Individual Pad
Heavy Die Cut Material	JOK22D	JOP22D



Replacement Pads

Western / American (Slip on)

Description	4 Piece Kit	Individual Pad
Molded Rubber Pad (like OEM)	JOK04M	JOP04M
Long Lasting Urethane (Yellow)	JOK04U	JOP04U

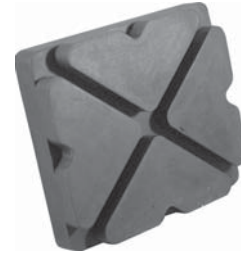

Wheeltronics / Snap-on / AMMCO-Round

Description	4 Piece Kit	Individual Pad
Molded Rubber Pad (Bolt On)	JOK16M	JOP16M



Wheeltronics / Snap-On / AMMCO - Square

Description	4 Piece Kit	Individual Pad
Molded Rubber Pad (like OEM)	JOK17M	JOP17M



If you don't see the pad you are looking for,

call us

we are adding new inventory every day!



Specialty Adapters

Benwill



Bottom OD	Height	
	3" - 6"	9" - 14"
2.5"	JO29-36	JO29-914
3"	JO30-36	JO30-914

Corvette



Bottom OD	Top Style	
	Round	Oval
1-1/8"	DICR-118	DICO-118
1-1/4"	DICR-120	DICO-120
1-3/8"	DICR-122	DICO-122
1-1/2"	DICR-124	DICO-124

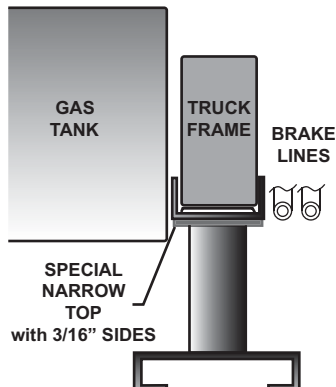

RAM

The RAM top is available in Drop ins, Spin ups,
Fixed and Adjustable Height Extensions

CUSTOM

If you do not see the extension you are looking for, call us!
We can custom make any height adapter you may need!

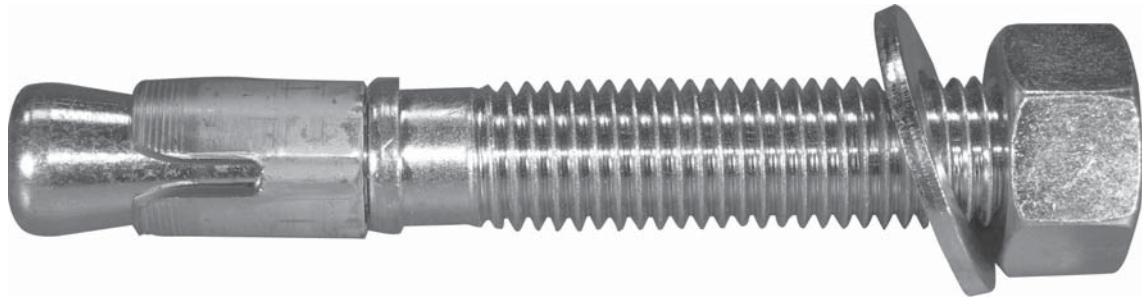

Anchor Bolts

**FREE SHIPPING
ON CASE
QUANTITIES**

See Page 2 for Details